



Aplus, Reliable Power Brand Deserve Your Trust

USER'S MANUAL

208/220/230/240VAC



Content

1. Safety Instructions	1	7. Typical Trouble Shooting	21
1.1 Installation.....	1	8. Maintenance	24
1.2 Operation.....	2	8.1 Operation.....	24
1.3. Maintenance, Servicing and Fault.....	2	8.2 Storage.....	24
1.4 Transport	3	9. Product Specification	25
1.5 Storage	3	9.1 Electrical Specification.....	25
2. Description of Commonly Used Notations	4	9.2 Environment Specification.....	26
3. Introduction	5	10. Communication Port	26
3.1 Functions Description.....	5	10.1 USB Interface(Optional).....	26
3.2 Front Panel.....	6	10.1 RS-232 Interface(Optional).....	26
4. Connection and Operation	8	11. Monitoring Software	27
4.1 Unpacking and Inspection.....	8	11.1 Free Software Download – WinPower.....	27
4.2 Installation Steps for Standard Model.....	8	11.2 Installation Procedure.....	27
4.3 Battery Recharge.....	9	Appendix 1: Rear Panel of 1KVA Tower UPS	28
4.4 Turn ON The UPS.....	9	Appendix 2: Rear Panel of 2KVA & 3KVA Tower UPS	29
4.5 Test Function.....	9		
4.6 Turn OFF The UPS.....	10		
4.7 Audible Alarm Mute Function.....	10		
5. Mode Description	11		
6. Setting by LCD Module	17		

1. Safety Instructions

Please read the following content and safety instructions before installation or operation.

1.1 Installation

- Condensation may occur if the UPS system is moved directly from a cold to a warm environment. The UPS system must be absolutely dry before being installed. Please allow an acclimatization time of at least two hours.
- Do not install the UPS system near water or in damp environments.
- Do not install the UPS system where it would be exposed to direct sunlight or near heat.
- Do not connect appliances or items of equipment which would overload the UPS system (e.g. laser printers) to the UPS output terminals or sockets.
- Place cables in such a way that no one can step on or trip over them.
- Assure to connect with the earth reliably.
- Connect the UPS only to a socket outlet which is earthed shockproof type.
- The building wiring socket outlet (shockproof socket outlet) must be easily accessible to close to the UPS.
- With the installation of the equipment, the sum of the leakage current of the UPS and the connected load does not exceed 3.5mA.
- Do not block ventilation openings on the UPS's housing. Ensure the air vents on the front, side and rear of the UPS are not blocked. Recommended at least 25cm of space on each side.
- This UPS receives power from more than one source-disconnection of AC source and the DC source is required to de-energize this unit before servicing.

- An additional circuit breaker or fuse with rating 15A and breaking capacity 3kA shall be used between power source and input when installation this unit.

1.2 Operation

- For safety consideration, do not disconnect the mains cable on the UPS or the building wiring socket (grounded shockproof socket) during operation the grounding for the UPS and all loads connected will be disconnected.
- The UPS features its own, internal current source (batteries). You may be electric shocked when you touch the UPS output sockets or output terminal block even if the UPS is not connected to the building wiring socket.
- In order to fully disconnect the UPS, first press the OFF button to turn off the UPS, and then disconnect the mains lead.
- Ensure that no liquid or other external objects can enter the UPS.
- Do not remove the enclosure. This system is to be serviced by qualified service person only. There are NO USER SERVICEABLE PARTS inside the UPS.
- Remove the protective panel only after disconnecting the terminal connections.

1.3 Maintenance, Servicing and Fault

- The UPS operates with hazardous voltages. Repairs may be carried out only by qualified maintenance/service person.
- Caution - risk of electric shock. Even after the unit is disconnected from the mains power supply (building wiring socket), components inside the UPS are still connected to the battery which are potentially dangerous.
- Before carrying out any kind of service and/or maintenance, disconnect the batteries. Verify that no current is present and no hazardous voltage exists in the capacitor or BUS capacitor terminals.
- Batteries must be replaced only by qualified person.
Caution - risk of electric shock. The battery circuit is not isolated from the

input voltage. Hazardous voltages may occur between the battery terminals and the ground. Verify that no voltage is present before servicing!

➤ Batteries have a high short-circuited current and pose a risk of shock. Take all precautionary measures specified below and any other measures necessary when working with batteries:

- remove all jewellery, wristwatches, rings and other metal objects
- use only tools with insulated grips and handles.
- Wear rubber gloves and boots.
- Do not lay tools or metal parts on top of batteries.
- Disconnect the charging source prior to connecting or disconnecting

battery terminals.

When changing batteries, replace with the same quantity and the same type of batteries.

- Do not attempt to dispose of batteries by burning them. It could cause explosion.
- Do not open or destroy batteries. Effluent electrolyte can cause injury to the skin and eyes, it may be toxic.
- Please replace the fuse only by a fuse of the same type and of the same amperage on order to avoid fire hazards.
- Do not dismantle the UPS, except the qualified maintenance person.

1.4 Transport











- Please transport the UPS only in the original packaging (to protect against shock and impact).

1.5 Storage

- The UPS must be stockpiled in the room where it is ventilated and dry.

2. Description of Commonly Used Notations

Some or all of the following notations may be used in this manual and may appear in your application process. Therefore, all users should be familiar with them and understand their explanations.

Nation and Explanation			
Nation	Explanation	Nation	Explanation
	Alert you to pay special attention		Protective ground
	Caution of high voltage		Overload indication
	ON/OFF		Bypass
	Alternating current source (AC)		Inverter
	Direct current source (DC)		Do not dispose with ordinary trash
	Battery		

3. Introduction

3.1 Functions Description

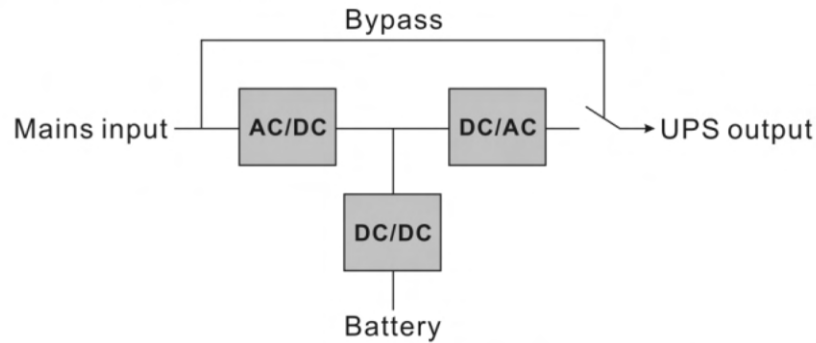

This product is a true online double-conversion UPS (Uninterruptible Power Supply). It provides perfect protection for critical load such as computer system. It can eliminate almost all mains power disturbances. The input AC current can be corrected to a wave following the mains voltage, so it is a high power factor system. Through the PWM control technology, the output voltage can be a pure & stable sine wave AC voltage.

When the mains input become abnormal, the controller will stop the AC/DC and start the DC/DC section immediately to make sure the DC/AC (inverter) section can continue to work. After the mains input comeback to normal range, the DC/DC will be stopped and the AC/DC works again. So the load is always power-supplied through inverter without any interrupt if the UPS is turned on.

The UPS also provides an internal bypass way to make the load can be powered by mains input directly when the UPS is off or failed.

The UPS have an internal charger for batteries, the charger will charge the batteries when the mains is in a reasonable range on “bypass mode” or “line mode”.

3.2 Front Panel

◆ LCD Display:

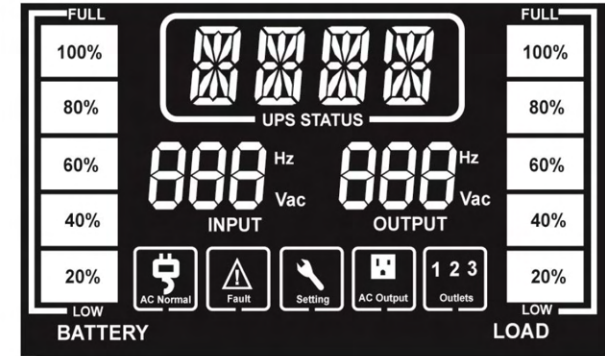

◆ Button Information:

Switch	Function
ON/MUTE-Button	1) Turn on UPS system: By pressing this Button, the UPS system is turned on. 2) Deactivate acoustic alarm: By pressing this Button, an acoustic alarm can be deactivated in the battery mode. 3) Do the battery test: By pressing this Button, UPS can do battery test in Line mode or ECO mode or Converter mode.
OFF-Button	1) When mains power is normal, the UPS system switches to No output or Bypass mode by pressing this Button, and the inverter is off. At this moment, if Bypass is enabled, then the output are supplied with voltage via the bypass if the mains power is available. 2) Deactivate acoustic alarm: By pressing this Button an acoustic alarm can be deactivated in the bypass mode. 3) Release the UPS back to Bypass mode or no output mode from fault mode.
SELECT-Button	If the UPS system is No output or Bypass mode, the output voltage, frequency, Bypass disable/enable and operating mode, could be selected by pressing SELECT-Button, and confirmed by pressing ENTER-Button
ENTER-Button	

◆ **LCD Display Information:**

Input information		Output information	
	It indicates input voltage/frequency value, which are displayed alternately.		It indicates output voltage/frequency value, which are displayed alternately.
	It indicates the input is connected with mains, and the input power is supplied from the mains.		It indicates the Output plug.
		1 2 3	It indicates the Number of the output connected with load.
Battery information		Load information	
	It indicates the battery capacity. Every grid represents the capacity of 20%.		It indicates the load level. Every grid represents the level of 20%.
Mode/Fault/Warning information		Else	
	It Indicates the operating mode or Fault kind or Warning kind, several warning kinds at the same time could be displayed alternately.		It indicates the UPS is in setting mode.
			It indicates the UPS is in Fault mode or has some warnings.

LCD idle function: If you enable LCD background idle function, When UPS is off to standby mode, LCD background will be turned off within 5 seconds. After any key pressed, the LCD background will be lighted on.

4. Connection and Operation

The system may be installed and wired only by qualified electricians in accordance with applicable safety regulations!

When installing the electrical wiring, please note the nominal amperage of your incoming feeder.

4.1 Unpacking and Inspection:

Inspect the appearance of the UPS to see if there is any damage during transportation. Do not turn on the unit and notify the dealer immediately if there is any damage or lack of some parts. Please keep the packaging in a safe place for future use.

Note: To avoid any safety issue, please ensure that the incoming feeder (mains) is isolated completely while whole installing process.

4.2 Installation Steps for Standard Model:

- 1) Make sure the wire / circuit breaker / socket are enough for the current rating of UPS to avoid the hazards of electric shock and fire. It is recommended to use 14AWG for 2KVA/3KVA.
- 2) Make sure the mains switch in the building is cut off.
- 3) Make sure the UPS is not being turned on before wiring operation.
- 4) Turn off all load switches first before connecting the load to the UPS.
- 5) Connect the loads to the UPS through the output sockets or terminal block.

4.3 Battery Recharge:

Fully charge the batteries of the UPS system by leaving the UPS system connected to the mains power for 1-2 hours approximately. The UPS system is able to operate directly without recharging process, but the backup time may be shorter than the nominal value specified

4.4 Turn ON The UPS:

1) With mains power connecting:

Press ON-Button continuously for more than 1 second to turn on the UPS, the UPS will get into the Line mode; the LCD screen will indicate the state of the UPS.

2) Without mains power connecting:

Even though mains power is not connected to the UPS, the UPS still can be turned on by just simply pressing ON-Button continuously for more than 1 second, then UPS will get into the Battery mode, and the LCD screen will indicate the state of the UPS.

Note: The default setting for bypass mode is no output after UPS is connecting mains power and breaker is turned on. This can be configurable.

4.5 Test Function:

Test function is checking battery performance of the UPS system by pressing the ON-Button for more than 1 second while UPS is operating in Line mode, the

UPS would detect whether the battery is connected or the battery is weak. And the UPS could also implement this test automatically and periodically, the period time is configurable.

4.6 Turn OFF The UPS:

1) In Line Mode:

Press OFF-Button continuously for more than 1 second to turn off the UPS, the UPS will get into no output or bypass mode. In circumstance, the UPS might have output power if bypass mode is enabled. Disconnect the mains power to turn off the output.

2) In Battery Mode:

Press OFF-Button continuously for more than 1 second to turn off the UPS, the UPS will get into no output or standby mode. After 10 seconds UPS will be shut down completely.

4.8 Audible Alarm Mute Function:

1) If the audio alarm is too annoying in battery mode, the audio alarm is able to mute by press ON-Button continuously for more than 1 second. Moreover, the audio alarm will be active again when the battery reaches low status for reminding that UPS output power will shut down soon.

2) If the audio alarm is too annoying in bypass mode, the audio alarm is able to mute by press OFF-Button continuously for more than 1 second. This action doesn't affect the warning and fault alarm.

3) In any mode, if the warning and fault alarm is too annoying, you can mute it by press ON-Button less than 0.5 second, and enable it by press ON-Button less than 0.5 second again. If the new warning or fault alarm is appeared, the buzzer will beep again.

4) Using the Converter mode, you may use it without batteries, if the open battery alarm is too annoying, you can mute it through software.

Here is an example for changing the Operating mode from normal mode to converter mode through the LCD display.

No.	Status	Alarm
1	Battery mode	Beep once every 4 sec
2	Battery mode with battery low	Beep once every sec
3	Bypass mode	Beep once every 2 min
4	Overload	Beep twice every sec
5	Warning active (see Warning& Fault Code Table)	Beep once every sec
6	Fault active	Beep continuously
7	Button function active	Beep once

5. Mode Description

Different messages/strings will be displayed on the LCD screen corresponding to different UPS operating modes, as shown in below Operating Mode code table. Different Warning/Fault code will be displayed as shown in the following table of Warning/Fault. Only one normal operating string or fault string is presented a time. However if several warnings happen at the same time, they will be displayed on the LCD alternately. In this case, the normal operating mode string and the warning string will be shown circularly. Once a fault comes forth, all previous warnings will not be shown again; only the fault string will be presented.

Operating Mode	Code
No output mode	STbY
Bypass mode	bYPA
Line mode	LINE
Battery mode	bATT
Battery test mode	TEST
ECO mode	ECO
Converter mode	CVCF

Operating Mode Code Table

Warning	Code
Site fail	SITE
Fan fail	FANF
Battery over voltage (over charged)	HIGH
Battery low	bLOW
Charge fail	CHGF
Inverter temperature high	TEPH
Battery open	bOPN
Overload	OVLd
Digital bigger charger fail	dCHF
Inner temperature high	ITPH

Warning Code Table

Fault	Code
Inverter Short	SHOR
Overload Fault	OVLd
Inverter Soft Start Fail	ISFT
Bus Soft Start Fail	bSFT
Over Temperature Fault	OVTp
Inverter Volt Low	INVL
Inverter Volt High	INVH
Bus Volt Over	bUSH
Bus Volt Low	bUSL
Bus Short	bUSS
Inverter NTC Open	NTCO

Fault Code Table

◆ No Output Mode

The LCD display in No output mode is shown in the following diagram. The information about the utility power, the battery level, the UPS output and the load level could be displayed. The “STbY” string indicates the UPS is working in the No output mode.



◆ Bypass Mode

Bypass mode means that the UPS provides the power through the internal bypass way to load directly without any regulation. If the controller detects the mains is abnormal, it will shut off the output to protect the load. The UPS bypass voltage/frequency range and default output status (on/off) could be set by communication software. However, UPS output power will be cut off if mains input range exceeds the setting value.

The LCD display in bypass mode is shown in the following diagram. The information about the utility power, the battery level, the UPS output and the load level could be displayed. The UPS will beep once every 2 minutes in bypass mode. The “bYPA” string indicates the UPS is working in the bypass mode.



◆ Line Mode

Line mode means that the mains input is rectified/converted by the AC/DC section and then inverted to stable output by DC/AC section. In line mode, the output is clean and good to the loads. If the mains get abnormal, the UPS will transfer to battery mode without interrupt.

The LCD display in Line mode is shown in the following diagram. The information about the utility power, the battery level, the UPS output and the load level could be displayed. The “LINE” string indicates the UPS is working in Line mode.

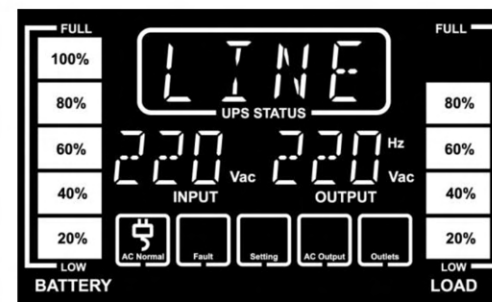

◆ Battery Mode

Battery mode means that the battery power goes through the DC/DC section to the inverter (DC/AC) and get a stable backup output when the mains input is not usable. If the mains input recovered, the UPS will transfer to line mode without interrupt.

The LCD display in battery mode is shown in the following diagram. The information about the utility power, the battery level, the UPS output and the load level could be displayed. The “bATT” string indicates the UPS is working in the battery mode.

When the UPS is running in battery mode, the buzzer beeps once every 4 seconds. If the ON-Button on the front panel is pressed for more than 1 second again, the buzzer will stop beeping (in silence mode). Press the ON-Button once again for more than 1 second to resume the alarm function.

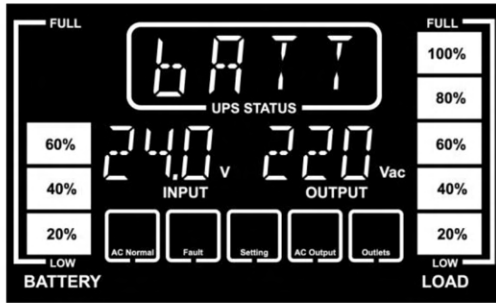

◆ Battery Test Mode

In this mode, the UPS will stop the AC/DC section and discharge the battery while mains input is normal. If the controller found the battery is error, it will transfer back to line mode immediately, and warning by display to see whether the battery needs to be replaced. The battery test mode could be triggered in line mode by pressing the button or by the communication command.

The LCD display in battery test mode is same as the battery mode, The “TEST” string indicates the UPS is working in the battery test mode.

◆ ECO Mode

It is also called high efficiency mode. In ECO mode, on LCD display, the mode string is “ECO”.

After the UPS is turned on, the power used by the load is supplied from the utility power via internal filter while the utility power is in normal range, so the high efficiency could be gained in the ECO mode. Once the mains is loss or abnormal, the UPS would transfer to battery mode and the load is supplied continuously by the battery.

- 1) It could be enabled through the LCD setting or the software (WinPower).
- 2) It is attention that the transfer time of UPS output from ECO mode to battery mode is less than 10ms. It is suggested to take account of applications for some sensitive load.

◆ Converter Mode

CVCF (Constant Voltage Constant Frequency) which is also called converter mode, the UPS would free run with fixed output frequency (50Hz or 60Hz) in converter mode. Once the mains is loss or abnormal, the UPS would transfer to battery mode and the load is supplied continuously by the battery.

- 1) It could be enabled through the LCD setting or the software (WinPower).
- 2) The load should be derating to 60% in converter mode.

◆ Fault Mode

If the UPS generates some internal failure and have to stop its inverter, it will go into fault mode and alarm by display and buzzer.

In fault mode, the loads have the risk of power loss because the output will come from the bypass after UPS fault.

In fault mode such as BUS fault etc., the corresponding fault string would be shown to indicate the operating mode of the UPS. For example “SHOR” would be shown when the load or the UPS output is short. The LCD display is shown in the following diagram.

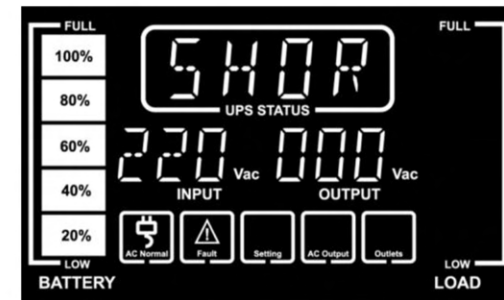

6. Setting by LCD Module

The output voltage/frequency, Auto bypass status, operating mode in No output mode or Bypass mode, charger current and battery remaining time function in all mode could be set directly through LCD module.

In bypass or no output mode, pressing the ENTER-Button on the LCD panel for more than 1 second to enter setting mode. The LCD display is shown in the following figure.



The string “OPV” that stands for output voltage. “230Vac” indicates the existing output voltage is 230Vac. if you want to set output voltage, press the ENTER-Button for more than 1 second, a flickering string “220” would be shown, if the ENTER-Button is pressed again, the string “220” turn to flickerless, the output volt is changed to 220V; if the SELECT-Button is pressed for more than 1 second, the next flickering string “230” appear, the order of flickering string is 220 – 230 – 240 – 220 – 230, Press ENTER-Button to confirm the output volt what you want.

To exit the setting mode that requests a pressing once on the ENTER-Button; to continue setting, press SELECT-Button. If no any pressing on the SELECT-Button or ENTER-Button lasting for more than 10 seconds, the setting mode will exit automatically.

The output frequency string “OPF”, Bypass status string ” bYPA”, operating mode string “MOdE”, battery remaining time string “bATT” , Charger current string”CHG” would be presented circularly. The only one voltage value can be selected in “220V”, “230V”, “240V” at any time; The only one frequency value can be selected in “50Hz”, “60Hz” at any time; Bypass status can be selected in Bypass Disable or Bypass Enable. The UPS would turn to bypass mode in several seconds if “Bypass Enable” is selected, and turn to no output mode in several seconds if “Bypass Disable” is selected; Operating mode can be selected in “UPS”(normal online mode), “ECO”(high efficiency mode), “CVF”(converter mode), The mode change would be active only after the UPS is turned on. The battery remaining time function could be selected in “000” or “001”. (Here 000 means battery remaining time function is disabled, then the battery remaining time could not display on LCD in battery mode. 001 means battery remaining time function is enabled, then in battery mode or battery test mode the battery remaining time (in unit Min or Sec) and string “bATT” would display on LCD in turn every 2s).



Step 1: “OPV” after pressing the ENTER-Button.



Step 2: “OPF” after pressing the SELECT-Button.



Step 3: “bYPA” after pressing the SELECT-Button.

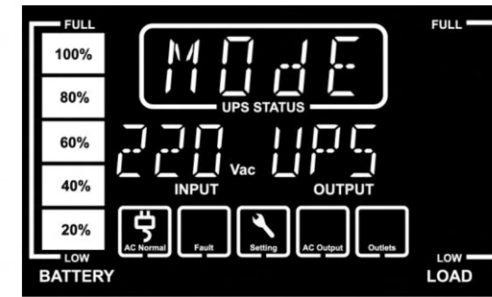

Step 4: “MOdE” after pressing the SELECT-Button. “UPS” is flickering after pressing the ENTER-Button.

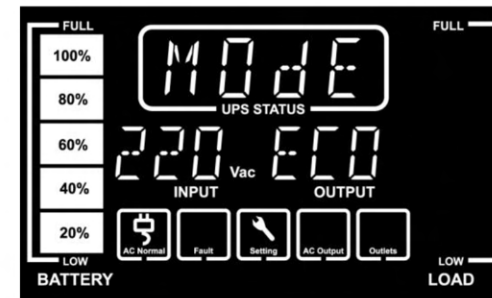

Step 5: “ECO” flickering after pressing the SELECT-Button.

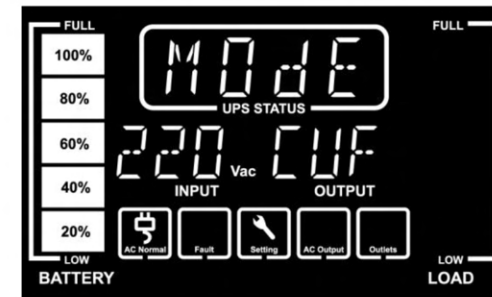

Step 6: “CVF” flickering after pressing the SELECT-Button. Press the ENTER-Button short touch ENTER-Button exit setting mode

7. Typical Trouble Shooting

If the UPS system does not operate correctly, first check the operating information on the LCD display. Please attempt to solve the problem using the table below. If the problem still persists, consult your dealer.

Code	Problem	Possible cause	Solution
N/A	No indication, no warning tone even though system is connected to mains power supply.	1) No input voltage. 2) Breaker open.	1) Check building wiring socket outlet and input cable. 2) Check the breaker.
N/A	No communication data.	Communication wire is not matched.	Check or change the communication wire.
N/A	Emergency supply period shorter than nominal value.	1) Batteries not fully charged. 2) Batteries defected.	1) Charge the batteries until the batteries are fully charge. 2) Change the batteries or consult your dealer.
FANF	Fan fail.	Fan abnormal.	Check if the fan is running.
HIGH	Battery over voltage.	Battery is over charged.	Switching to battery mode automatically, and after the battery voltage is normal and the mains is normal, the UPS would switch to Line mode automatically again.
bLOW	Battery low.	Battery voltage is low.	When audible alarm sounding every second, battery is almost empty.

bOPN	Battery open.	Battery pack is not connected correctly.	Do the battery test to confirm. Check the battery bank is connected to the UPS. Check the battery breaker is turn on.
CHGF	Charger fail.	The charge is broken.	Notify dealer.
dCHF	Digital bigger charger fail.	The charge is broken.	Notify dealer.
bUSH	Bus high.	UPS internal fault.	Notify dealer.
bUSL	Bus low.	UPS internal fault.	Notify dealer.
bSFT	Bus soft start fail.	UPS internal fault.	Notify dealer.
bUSS	Bus short.	UPS internal fault.	Notify dealer.
TEPH	Inverter temperature high.	Inside temperature of the UPS is too high.	Check the ventilation of the UPS, check the ambient temperature.
ITPH	Inner ambient temperature high.	The ambient temperature is too high.	Check the environment temperature.
INVH	Inverter high.	UPS internal fault.	Notify dealer.
INVL	Inverter low.	UPS internal fault.	Notify dealer.
ISFT	Inverter soft start fail.	UPS internal fault.	Notify dealer.
NTCO	Inverter NTC open.	UPS internal fault..	Notify dealer.

SHOR	Inverter short.	Output short circuit.	Remove all the loads. Turn off the UPS. Check whether the output of UPS and loads is short circuit. Make sure the short circuit is removed, and the UPS has no internal faults before turning on again.
OVTP	Over temperature fault.	Over temperature.	Check the ventilation of the UPS, check the ambient temperature and ventilation.
OVLD	Overload.	Overload.	Check the loads and remove some non-critical loads. Check whether some loads are failed.
SITE	Site fail.	Phase and neutral conductor at input of UPS system are reversed.	Rotate mains power socket by 180° or connect UPS system.

Please have the following information at hand before calling for service.

- 1) Model number, serial number
- 2) Date on which the problem occurred
- 3) LCD display information, buzzer alarm status
- 4) Mains power condition, load type and capacity, environment temperature, ventilation condition
- 5) The information battery capacity, quantity.
- 6) Other information for complete description of the problem

8. Maintenance

8.1 Operation

The UPS system contains no user-serviceable parts.

8.2 Storage

If the batteries are stored in temperate climatic zones, it is recommended to recharge those batteries every three months for 1~2 hours. It is highly suggested to shorten the recharging intervals in every two months at locations where subjects to high temperatures.

9. Product Specification

9.1 Electrical Specification

Model	1KVA	2KVA	3KVA
Power	1000VA	2000VA	3000VA
Input			
Normal Current (@230V/battery recharged fully)	4.3A	8.7A	13A
Voltage Range	100~300VAC		
Frequency Range	45 ~ 55Hz @ 50Hz system 54 ~ 66Hz @ 60Hz system		
Current Distortion(THDi)	<5% (typical) @ 100% linear load		
Output			
Voltage	200/208/220/230/240 ± 2%		
Frequency (battery mode)	50/60Hz ± 0.05Hz		
Current Crest Ratio	3:1		
Voltage Distortion (THDv)	< 1% @ linear load, < 5%@ non-linear load		
Output Waveform	Pure sine wave		
Efficiency			
Inverter Mode	> 88%	> 90%	> 90%
ECO Mode	> 97%		
Battery			
Rated Battery Voltage	24VDC	48VDC	72VDC
Battery Type	12V/9AH	12V/9AH	12V/9AH
Number of Internal Battery	2	4	6
Backup Time (@ Full Load)	> 3.5 mins	> 3.5 mins	> 3.5 mins
Recharge Time (to 90%)	4 hours	4 hours	4 hours

9.2 Environment Specification

Model	1KVA	2KVA	3KVA
Ambient Temperature	0°C ~ 40°C		
Storage Temperature	-25°C ~ 55°C		
Noise Level	40dB @1 meter		50dB @1 meter
Altitude	< 1000m (The load no derating)		
	1000m < Altitude ≤ 3000m (The load should derating 1 % for every up 100m)		
Relative Humidity	<95%		

10. Communication Port

The communication port is for the monitoring software and program update.

10.1 USB Interface(Optional)

The USB port is compliance with USB 1.1 protocol.

10.2 RS-232 Interface(Optional)

11. Monitoring Software

11.1 Free Software Download – WinPower

WinPower is a brand new UPS monitoring software, which provides user-friendly interface to monitor and control your UPS. This unique software provides safely auto shutdown for multi-computer systems while power failure. With this software, users can monitor and control any UPS on the same LAN no matter how far from the UPS.

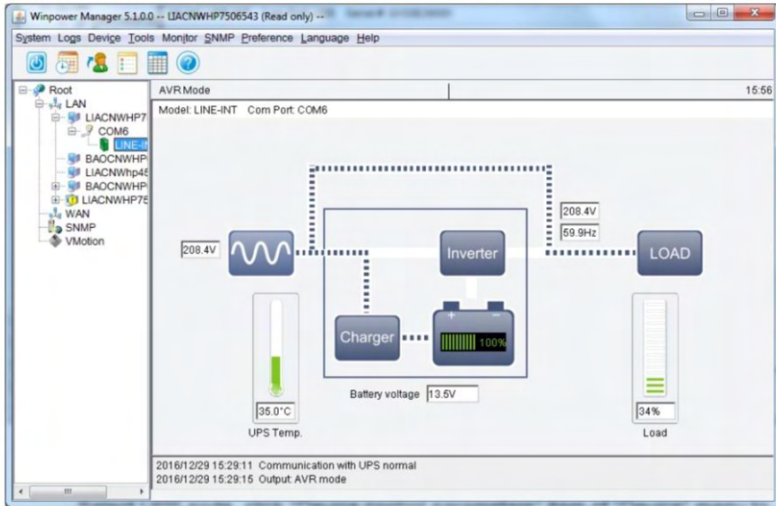

11.2 Installation Procedure:

1. Go to the website:
<http://www.ups-software-download.com/content/ups-download-software/download.html>
 2. Choose the operation system you need and follow the instruction described on the website to download the software.
 3. When downloading all required files from the internet, enter the serial No: **511C1-01220-0100-478DF2A** to install the software.
- When your computer restarts, the WinPower software will appear as a green plug icon located in the system tray, near the clock.

Appendix 1: Rear Panel of 1KVA Tower UPS

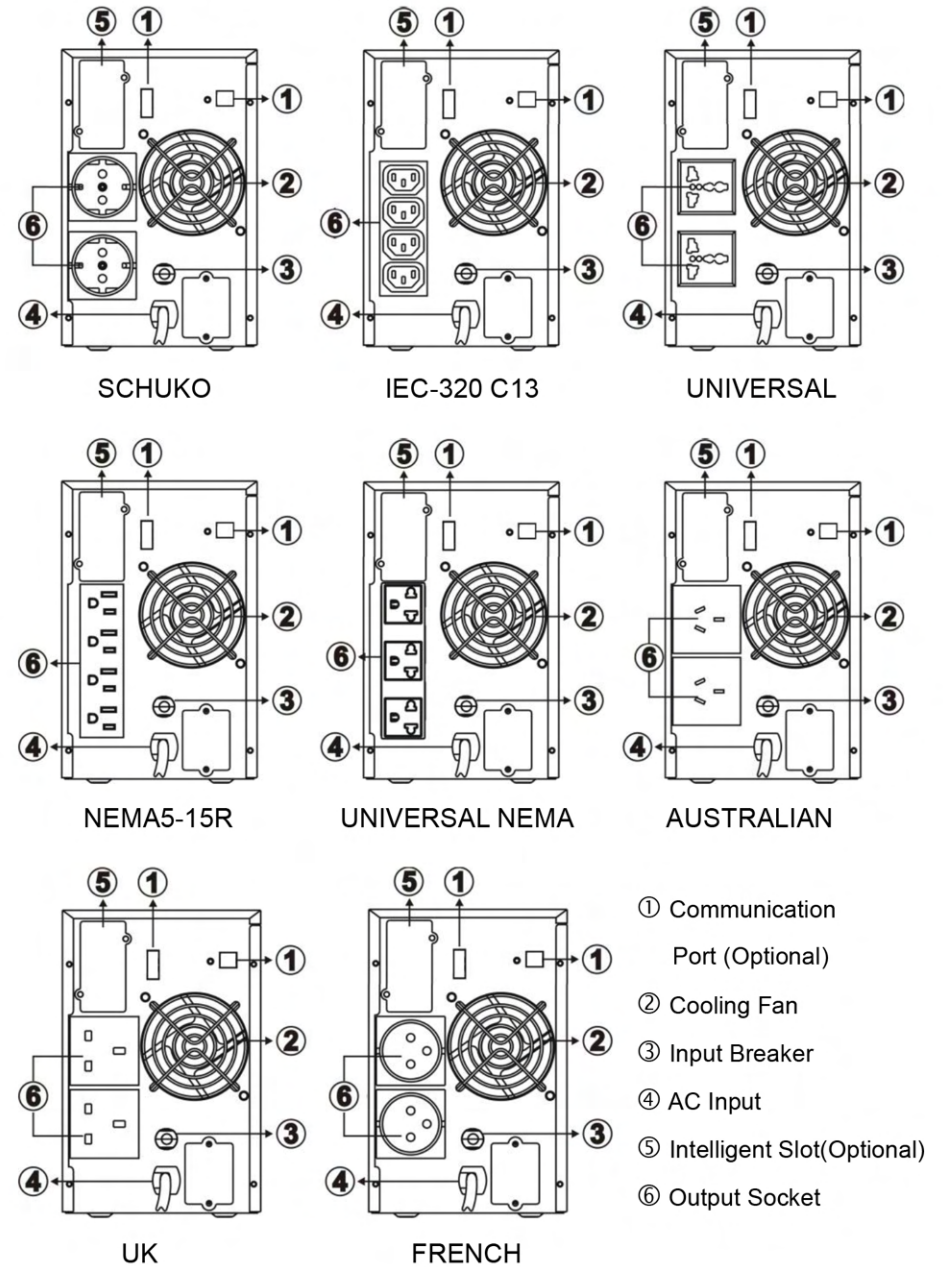

Appendix 2: Rear Panel of 2KVA & 3KVA Tower UPS

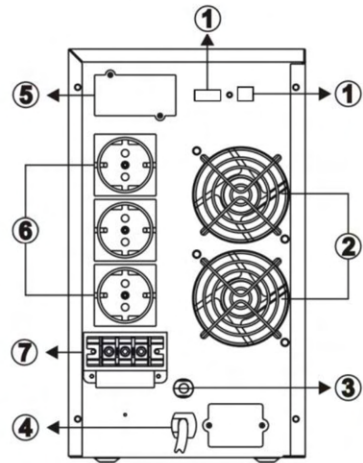

SCHUKO

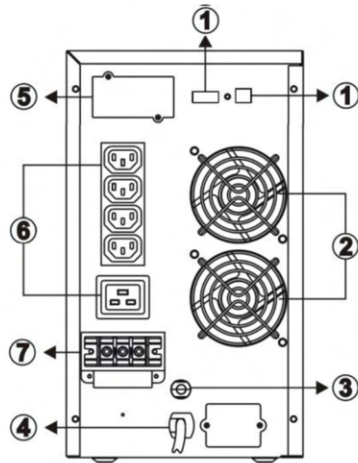

IEC-320

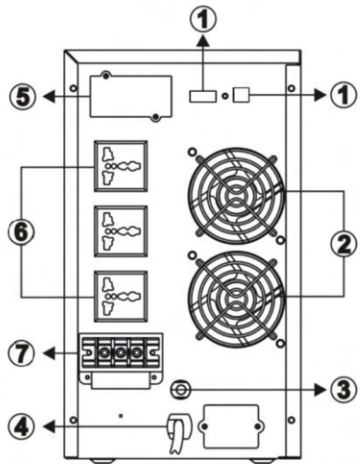

UNIVERSAL

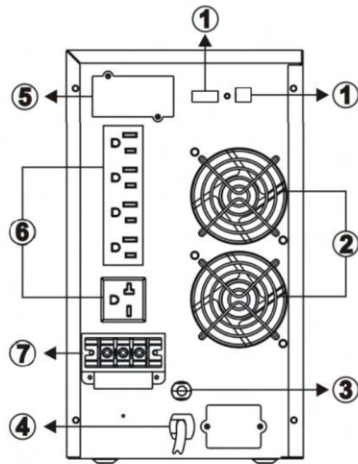

NEMA

- ① Communication Port (Optional)
- ② Cooling Fan
- ③ Input Breaker
- ④ AC Input

- ⑤ Intelligent Slot(Optional)
- ⑥ Output Socket
- ⑦ Output Terminal(Optional)

Appendix 2: Rear Panel of 2KVA & 3KVA Tower UPS

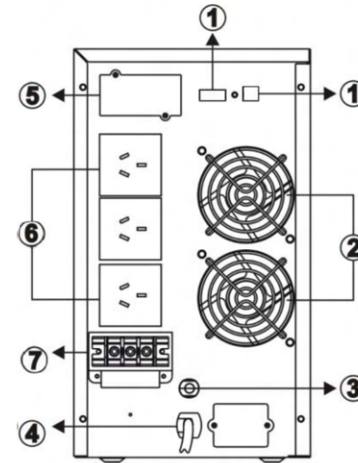

AUSTRALIAN

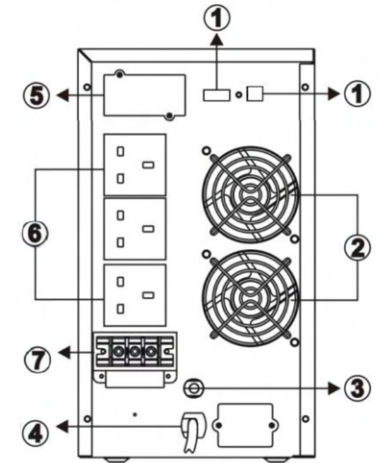

UK

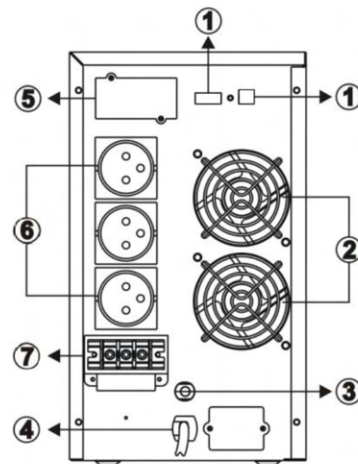

FRENCH

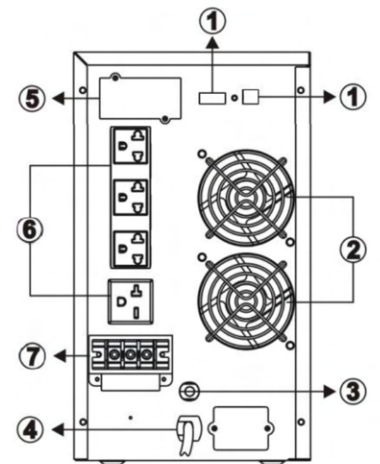

UNIVERSAL NEMA

- ① Communication Port (Optional)
- ② Cooling Fan
- ③ Input Breaker
- ④ AC Input

- ⑤ Intelligent Slot(Optional)
- ⑥ Output Socket
- ⑦ Output Terminal(Optional)

701-0071733 UPS-AplusB-9200LB-R232-E-01